

## Data sheet | Item number: 769-674/003-000

THT male header; 1.0 x 1.0 mm solder pin; angled; clamping collar; Pin spacing 5 mm; 14-pole; gray

[www.wago.com/769-674/003-000](http://www.wago.com/769-674/003-000)



**i** Picture differs from the item.

Color:

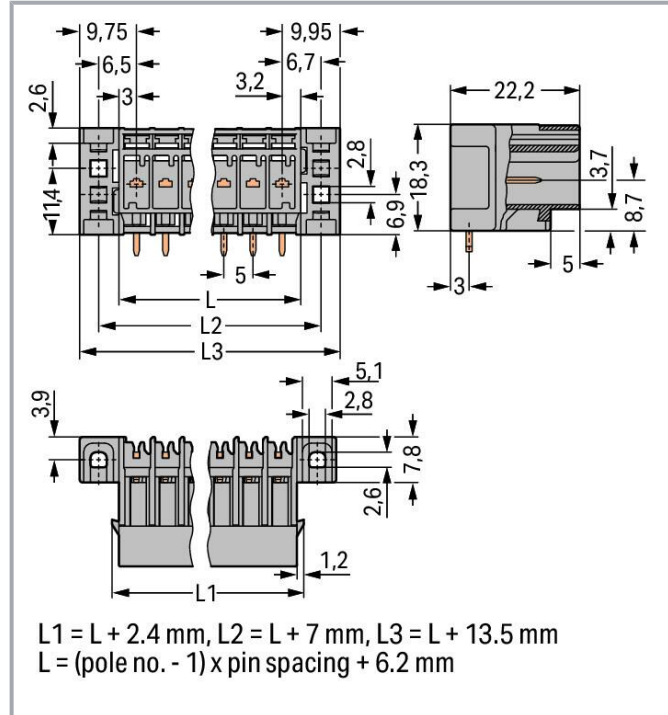

## Data

### Electrical data

### Ratings per IEC/EN

Nominal voltage (III/3)	250 V
Rated impulse voltage (III/3)	4 kV
Rated voltage (III/2)	500 V
Rated impulse voltage (III/2)	4 kV
Rated current	32 A
Legend (ratings)	(III / 3) $\hat{=}$ Overvoltage category III / Pollution degree 3

Subject to changes. Please also observe the further product documentation!

WAGO GmbH & Co. KG  
Hansastr. 27  
32423 Minden  
Phone: +49571 887-0 | Fax: +49571 887-169  
Email: [info.de@wago.com](mailto:info.de@wago.com) | Web: [www.wago.com](http://www.wago.com)

Do you have any questions about our products?  
We are always happy to take your call at +49 (571) 887-44222.

## Connection data

Total number of potentials	14
Number of levels	1
Preceding contacts	No

## Connection 1

Pole number	14
-------------	----

## Physical data

Pin spacing	5 mm / 0.197 inches
Width	84.7 mm / 3.335 inches
Height from the surface	18.3 mm / 0.72 inches
Depth	22.2 mm / 0.874 inches

## Mechanical Data

Variable coding	Yes
Mounting type	Mounting flange
Anti-rotation protection	Yes

## Plug-in connection

Contact type (pluggable connector)	Male connector/plug
Connector (connection type)	for PCB
Mismating protection	No
Plugging without loss of pin spacing	No
Mating direction to the PCB	0°

## PCB contact

PCB contact	THT
-------------	-----

## Material Data

Note (material data)	<a href="#">Information on material specifications can be found here</a>
Color	gray
Material group	I

Subject to changes. Please also observe the further product documentation!

Insulation material	Polyamide (PA66)
Flammability class per UL94	V0
Fire load	0.414 MJ
Weight	15.4 g

### Environmental requirements

Processing temperature	-35 ... +85 °C
Continuous operating temperature	-60 ... +105 °C

### Commercial data

Product Group	18 (X-COM-System)
eCl@ss 10.0	27-44-04-02
eCl@ss 9.0	27-44-04-02
ETIM 8.0	EC002637
ETIM 7.0	EC002637
PU (SPU)	15 pcs
Packaging type	box
Country of origin	PL
GTIN	4044918397414
Customs tariff number	85366990990

### Environmental Product Compliance





RoHS Compliance Status	Compliant, No Exemption
------------------------	-------------------------

### Approvals / Certificates

#### General approvals

Logo	Approval	Additional Approval Text	Certificate name
	CCA DEKRA Certification B.V.	EN 60947	NTR NL-7626
	CCA DEKRA Certification B.V.	EN 61984	2190419.02
	CCA DEKRA Certification B.V.	IEC 61984	NL-47799 /A1

Subject to changes. Please also observe the further product documentation!

	CSA DEKRA Certification B.V.	C22.2 No. 158	1101144
	KEMA/KEUR DEKRA Certification B.V.	EN 60947	2190419.01
	UL Underwriters Laboratories Inc.	UL 1977	E 45171
	UR Underwriters Laboratories Inc.	UL 1059	E45172

**Declarations of conformity and manufacturer's declarations**

Logo	Approval	Additional Approval Text	Certificate name
	EU-Declaration of Conformity WAGO GmbH & Co. KG	-	-
	UK-Declaration of Conformity WAGO GmbH & Co. KG	-	-

**Approvals for marine applications**

Logo	Approval	Additional Approval Text	Certificate name
	DNV GL Det Norske Veritas, Germanischer Lloyd	-	TAE00001V2

**Optional accessories**

**Marking accessories**

Marking strip			
	Item no.: 210-831 Marking strips; on reel; 2.3 mm wide; plain; Self-adhesive; white		<a href="http://www.wago.com/210-831">www.wago.com/210-831</a>

Subject to changes. Please also observe the further product documentation!



**Item no.: 210-833**  
Marking strips; 25 m on roll; 6 mm wide; plain; Self-adhesive; white

[www.wago.com/210-833](http://www.wago.com/210-833)



**Item no.: 210-834**  
Marking strips; on reel; 5 mm wide; plain; Self-adhesive; white

[www.wago.com/210-834](http://www.wago.com/210-834)



**Item no.: 210-832**  
Marking strips; on reel; 3 mm wide; plain; Self-adhesive; white

[www.wago.com/210-832](http://www.wago.com/210-832)

### Coding

Coding



**Item no.: 769-435**  
Coding pin; for coding of female plugs; for carrier terminal blocks / male connectors; orange

[www.wago.com/769-435](http://www.wago.com/769-435)

### Downloads

#### Documentation

##### Bid Text

769-674/003-000 X81 - Datei	2019 Feb 19	xml 3.1 kB	Download
769-674/003-000 doc - Datei	2017 Oct 4	doc 25.6 kB	Download

##### Additional Information

Technical Section Technical explanations		pdf 2.2 MB	Download
---	--	---------------	----------

### CAD/CAE-Data

#### CAD data

2D/3D Models 769-674/003-000		URL	Download
------------------------------	--	-----	----------

#### PCB Design

Symbol and Footprint 769-674/003-000		URL	Download
--------------------------------------	--	-----	----------

CAX data for your PCB design, consisting of "schematic symbols and PCB footprints", allow easy integration of the WAGO component into your development environment.

#### Supported formats:

Subject to changes. Please also observe the further product documentation!



- Accel EDA 14 & 15
- Altium 6 to current version
- Cadence Allegro
- DesignSpark
- Eagle Libraries
- KiCad
- Mentor Graphics BoardStation
- Mentor Graphics Design Architect
- Mentor Graphics Design Expedition 99 and 2000
- OrCAD 9.X PCB and Capture
- PADS PowerPCB 3, 3.5, 4.X, and 5.X
- PADS PowerPCB and PowerLogic 3.0
- PCAD 2000, 2001, 2002, 2004, and 2006
- Pulsonix 8.5 or newer
- STL
- 3D STEP
- TARGET 3001!
- View Logic ViewDraw
- Quadcept
- Zuken CadStar 3 and 4
- Zuken CR-5000 and CR-8000

PCB Component Libraries (EDA), PCB CAD Library Ultra Librarian

---

#### CAE data

ZUKEN Portal 769-674/003-000	<a href="#">URL</a>	<a href="#">Download</a>
------------------------------	---------------------	--------------------------

---

## Environmental Product Compliance

### Compliance Search

Environmental Product Compliance 769-674/003-000 THT male header; 1.0 x 1.0 mm solder pin; angled; clamping collar; Pin spacing 5 mm; 14-pole; gray	<a href="#">URL</a>	<a href="#">Download</a>
---	---------------------	--------------------------

---

## Installation Notes

### Application

Subject to changes. Please also observe the further product documentation!

---

WAGO GmbH & Co. KG  
Hansastr. 27  
32423 Minden  
Phone: +49571 887-0 | Fax: +49571 887-169  
Email: [info.de@wago.com](mailto:info.de@wago.com) | Web: [www.wago.com](http://www.wago.com)

Do you have any questions about our products?  
We are always happy to take your call at +49 (571) 887-44222.

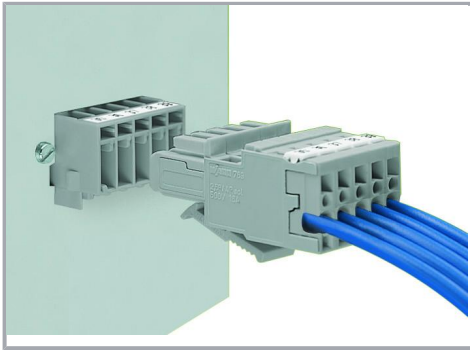

Male header with mounting flanges

1-conductor female plug with bottom-mount locking levers

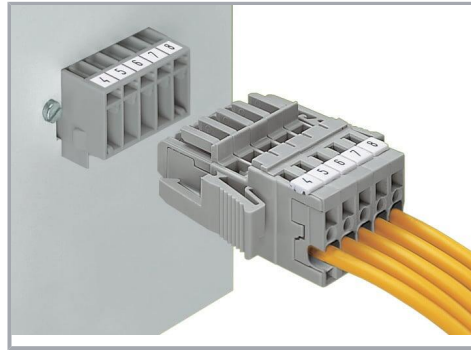

Male header with mounting flanges

1-conductor female plug with lateral locking levers

## Product family

### X-COM

[Show all products from the family](#)

Subject to changes. Please also observe the further product documentation!